

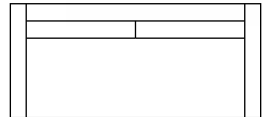

N·C·MADE

# THE SATURDAY UP-SLOPE ARM

WITH THIN FRONT RAIL • 7" LEGS



<b>57520</b>
108lbs.   LOVESEAT
TOTAL   W59" D37" H32"
SEAT   W53" D22" H18"
ARMS   --- --- H24"

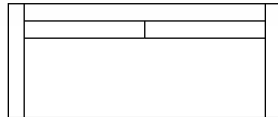

<b>57535</b>
115lbs.   APARTMENT SOFA
TOTAL   W76" D37" H32"
SEAT   W68" D22" H18"
ARMS   --- --- H24"

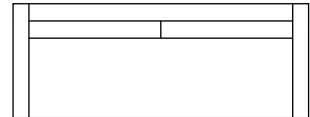

<b>57530</b>
140lbs.   86" SOFA
TOTAL   W86" D37" H32"
SEAT   W78" D22" H18"
ARMS   --- --- H24"

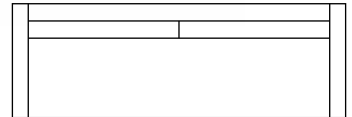

<b>57580</b>
170lbs.   96" SOFA
TOTAL   W96" D37" H32"
SEAT   W88" D22" H18"
ARMS   --- --- H24"

SATURDAY UP-SLOPE ARM ALSO AVAILABLE WITH LARGER FRONT RAIL AND 2" LEGS AS 525 GROUP. SEE 1:1 BOOKLET FOR MORE INFORMATION. SEE REVERSE FOR SECTIONAL OPTIONS.



<b>55009</b>	<b>CORNER CHAIR</b>
80lbs.	
<b>TOTAL</b>	W37" D37" H32"
<b>SEAT</b>	W22" D22" H18"
<b>ARMS</b>	--- --- ---



<b>57511</b>	<b>RIGHT ARM CHAIR</b>
80lbs.	
<b>TOTAL</b>	W30" D37" H32"
<b>SEAT</b>	W26" D22" H18"
<b>ARMS</b>	--- --- H24"



<b>57512</b>	<b>LEFT ARM CHAIR</b>
80lbs.	
<b>TOTAL</b>	W30" D37" H32"
<b>SEAT</b>	W26" D22" H18"
<b>ARMS</b>	--- --- H24"



<b>55013</b>	<b>ARMLESS CHAIR</b>
80lbs.	
<b>TOTAL</b>	W26" D37" H32"
<b>SEAT</b>	W26" D22" H18"
<b>ARMS</b>	--- --- ---

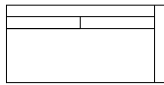

<b>57521</b>	<b>R. ARM LOVESEAT</b>
108lbs.	
<b>TOTAL</b>	W56" D37" H32"
<b>SEAT</b>	W53" D22" H18"
<b>ARMS</b>	--- --- H24"

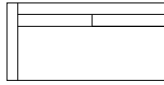

<b>57522</b>	<b>L. ARM LOVESEAT</b>
108lbs.	
<b>TOTAL</b>	W56" D37" H32"
<b>SEAT</b>	W53" D22" H18"
<b>ARMS</b>	--- --- H24"

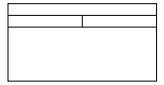

<b>55023</b>	<b>ARMLESS LOVESEAT</b>
95lbs.	
<b>TOTAL</b>	W52" D37" H32"
<b>SEAT</b>	W52" D22" H18"
<b>ARMS</b>	--- --- ---



<b>57531</b>	<b>R. CORNER SOFA</b>
180lbs.	
<b>TOTAL</b>	W92" D37" H32"
<b>SEAT</b>	W79" D22" H18"
<b>ARMS</b>	--- --- H24"

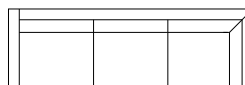

<b>57532</b>	<b>L. CORNER SOFA</b>
180lbs.	
<b>TOTAL</b>	W92" D37" H32"
<b>SEAT</b>	W79" D22" H18"
<b>ARMS</b>	--- --- H24"

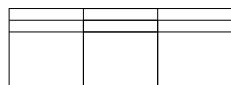

<b>55033</b>	<b>ARMLESS SOFA</b>
120lbs.	
<b>TOTAL</b>	W78" D37" H32"
<b>SEAT</b>	W78" D22" H18"
<b>ARMS</b>	--- --- ---

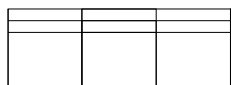

<b>57533</b>	<b>R. ARM SOFA</b>
125lbs.	
<b>TOTAL</b>	W82" D37" H32"
<b>SEAT</b>	W78" D22" H18"
<b>ARMS</b>	--- --- H24"



<b>57534</b>	<b>L. ARM SOFA</b>
125lbs.	
<b>TOTAL</b>	W82" D37" H32"
<b>SEAT</b>	W78" D22" H18"
<b>ARMS</b>	--- --- H24"

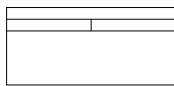

<b>55035</b>	<b>ARMLESS APT. SOFA</b>
100lbs.	
<b>TOTAL</b>	W68" D37" H32"
<b>SEAT</b>	W68" D22" H18"
<b>ARMS</b>	--- --- ---

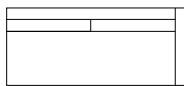

<b>57536</b>	<b>R. ARM APT. SOFA</b>
125lbs.	
<b>TOTAL</b>	W72" D37" H32"
<b>SEAT</b>	W68" D22" H18"
<b>ARMS</b>	--- --- H24"

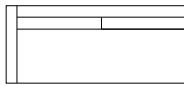

<b>57537</b>	<b>L. ARM APT. SOFA</b>
125lbs.	
<b>TOTAL</b>	W72" D37" H32"
<b>SEAT</b>	W68" D22" H18"
<b>ARMS</b>	--- --- H24"

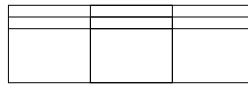

<b>55039</b>	<b>LG. ARMLESS SOFA</b>
140lbs.	
<b>TOTAL</b>	W88" D37" H32"
<b>SEAT</b>	W88" D22" H18"
<b>ARMS</b>	--- --- ---

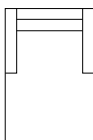

<b>57560</b>	<b>CHAISE</b>
125lbs.	
<b>TOTAL</b>	W38" D63" H32"
<b>SEAT</b>	W30" D22" H18"
<b>ARMS</b>	--- --- H24"

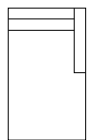

<b>57561</b>	<b>R. ARM CHAISE</b>
125lbs.	
<b>TOTAL</b>	W34" D63" H32"
<b>SEAT</b>	W30" D22" H18"
<b>ARMS</b>	--- --- H24"

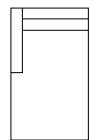

<b>57562</b>	<b>L. ARM CHAISE</b>
125lbs.	
<b>TOTAL</b>	W34" D63" H32"
<b>SEAT</b>	W30" D22" H18"
<b>ARMS</b>	--- --- H24"



<b>55063</b>	<b>ARMLESS CHAISE</b>
125lbs.	
<b>TOTAL</b>	W30" D63" H32"
<b>SEAT</b>	W30" D22" H18"
<b>ARMS</b>	--- --- ---

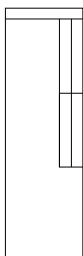

<b>55071</b>	<b>R. ARM BUMPER</b>
136lbs.	
<b>TOTAL</b>	W37" D85" H32"
<b>SEAT</b>	W22" D70" H18"
<b>ARMS</b>	--- --- ---

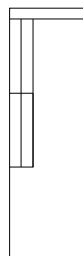

<b>55072</b>	<b>L. ARM BUMPER</b>
136lbs.	
<b>TOTAL</b>	W37" D85" H32"
<b>SEAT</b>	W22" D70" H18"
<b>ARMS</b>	--- --- ---

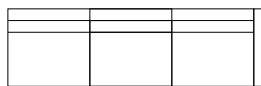

<b>57581</b>	<b>R. ARM LG. SOFA</b>
160lbs.	
<b>TOTAL</b>	W92" D37" H32"
<b>SEAT</b>	W88" D22" H18"
<b>ARMS</b>	--- --- H24"

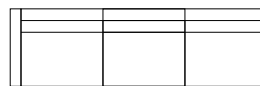

<b>57582</b>	<b>L. ARM LG. SOFA</b>
160lbs.	
<b>TOTAL</b>	W92" D37" H32"
<b>SEAT</b>	W88" D22" H18"
<b>ARMS</b>	--- --- H24"

SATURDAY UP-SLOPE ARM ALSO AVAILABLE WITH LARGER FRONT RAIL AND 2" LEGS AS 525 GROUP.  
SEE 1:1 BOOKLET FOR MORE INFORMATION.